

DSD/Q  
**Design  
Program**  
Available

**Ancon**<sup>®</sup>  
**DSD/ESD**  
**Shear Load Connectors**  
for the Construction Industry



# **We are one team.** **We are Leviat.**

Leviat is the new name of CRH's construction accessories companies worldwide.

Under the Leviat brand, we have united the expertise, skills and resources of Ancon and its sister companies to create a world leader in fixing, connecting and anchoring technology.

The products you know and trust will remain an integral part of Leviat's comprehensive brand and product portfolio. As Leviat, we can offer you an extended range of specialist products and services, greater technical expertise, a larger and more agile supply chain and better, faster innovation.

By bringing together CRH's construction accessories family as one global organisation, we are better equipped to meet the needs of our customers, and the demands of construction projects, of any scale, anywhere in the world.

**This is an exciting change. Join us on our journey.**

**Read more about Leviat at [Leviat.com](https://www.leviat.com)**



Our product brands include:

**Ancon**

  
**HALFEN**

**HELIFIX** 

 **ISEDIO**

**PLAKA**



**60**  
locations

sales in  
**30+**  
countries

**3000**  
people worldwide

Imagine. Model. Make.

[Leviat.com](http://Leviat.com)

# Shear Load Connectors

## Efficiently transfer shear load across movement joints in concrete

Reinforced concrete is an important construction material. It offers strength, durability and can be formed into a variety of shapes. Concrete structures are designed with expansion and contraction joints at appropriate places to allow movement to take place. The design of the joint is important for the overall design to function correctly.

Ancon shear load connectors offer significant advantages over plain dowels. These connectors are more effective at transferring load and allowing movement to take place, easier to fix on site and can prove a more cost-effective solution.

Each connector is a two-part assembly comprising a sleeve and a dowel component. Installation is a fast and accurate process, drilling of either formwork or concrete is not

required. The sleeve is simply nailed to the formwork ensuring subsequent alignment with the dowel, essential for effective movement.

They are manufactured from stainless steel to ensure a high degree of corrosion resistance with no requirement for additional protection.

In most cases, dowelled or keyed joints can be replaced by joints incorporating Ancon shear load connectors. They can be used for movement joints in floor slabs, suspended slabs, and for replacing double columns and beams at structural movement joints.

Applications in civil engineering include joints in bridge parapets, bridge abutments and diaphragm wall construction.

### Building Information Modelling

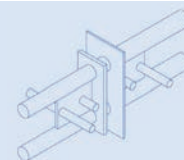

BIM objects of Ancon products are now available to download from either [www.ancon.co.uk/BIM](http://www.ancon.co.uk/BIM) or the NBS National BIM Library.



## Contents

<u>Dowelled and Keyed Joints</u>	<u>4</u>	<u>DSD and DSDQ Connectors</u>	<u>10-14</u>
<u>Ancon Solutions to Joints</u>	<u>5</u>	<u>ESD, ESDQ, ED and Acoustic Connectors</u>	<u>15-18</u>
<u>Ancon Shear Connector Range</u>	<u>6-7</u>	<u>Applications</u>	<u>19</u>
<u>Installation Procedure</u>	<u>8</u>	<u>Other Ancon Products</u>	<u>19</u>
<u>Design Resistances</u>	<u>9</u>		



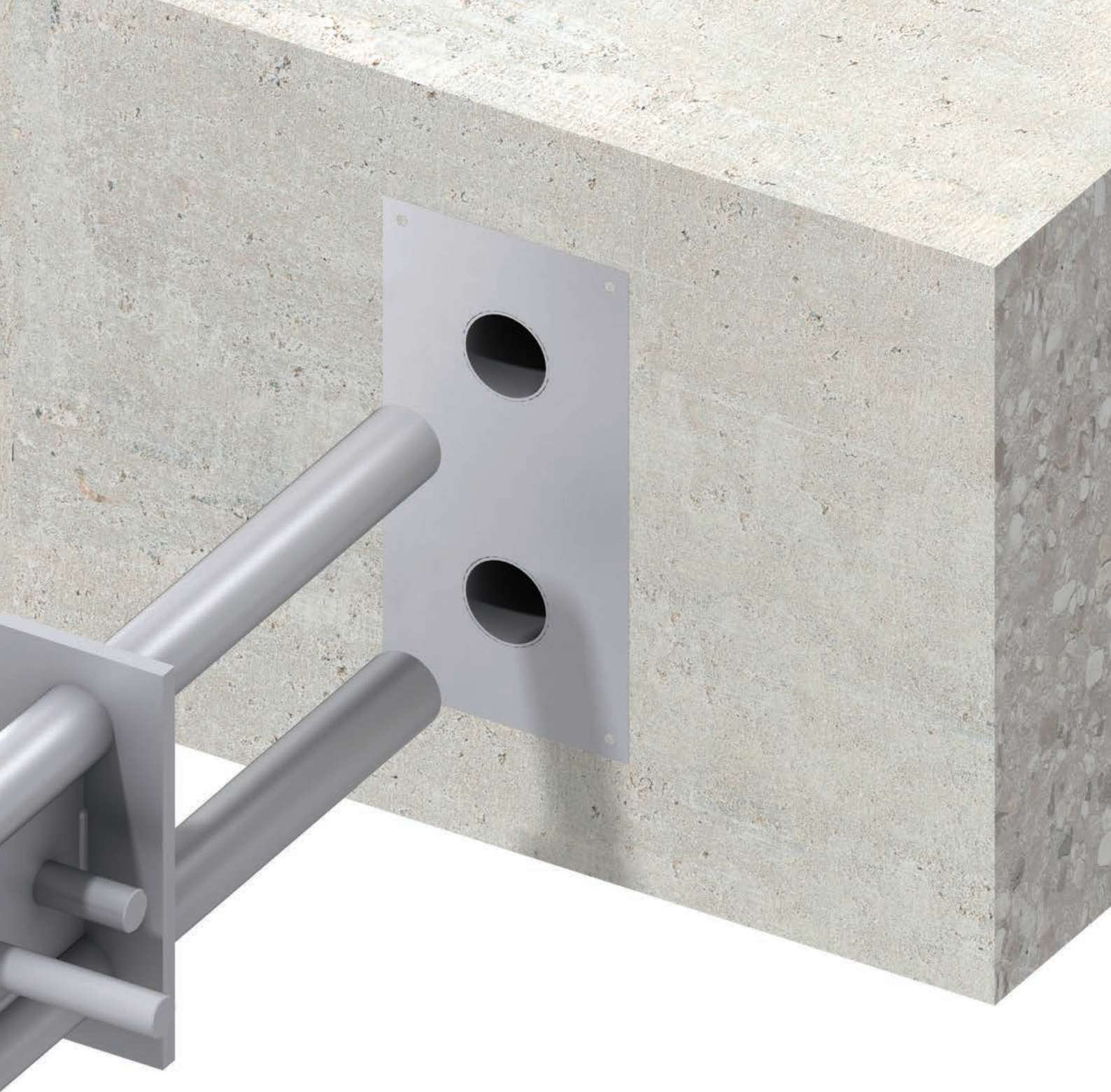

**High Load  
Transfer**



**Sleeve Component  
Accommodates  
Movement**



**'Q' Range Allows Lateral  
Movement**



**Two Step Installation  
Guarantees Alignment**



**Corrosion Resistant  
Stainless Steel**



**Acoustic Resilient  
Dowel Available**



**Design Program Available**



**BIM Objects  
Available**



Scan to view  
this product  
on our website



# DSD/ESD Shear Load Connectors

## Dowelled Joints

Dowels are used to transfer shear across construction and movement joints in concrete. They are often either cast or drilled into the concrete. A single row of short thick dowels provides reasonable shear transfer but suffers from deformation. This can lead to stress concentrations, resulting in subsequent spalling of the concrete.

Where dowels are used across expansion and contraction joints, half the length of the bar is debonded to allow movement to take place.

Dowelled joints either require formwork to be drilled for the dowels to pass through, or concrete to be drilled for dowels to be resin fixed in one side.

At movement joints, dowels will need to be accurately aligned in both directions to ensure movement can actually take place, otherwise cracking is likely to occur.

Plain dowels are not very effective when used across joints wider than 10mm.

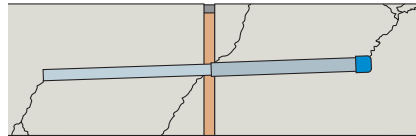

## Keyed Joints

Keyed joints require complicated formwork to create the tongue and groove. If the joint is not formed correctly, differential movement can take place. Load is transferred through the locally reduced section of the joint which can at times result in cracking.

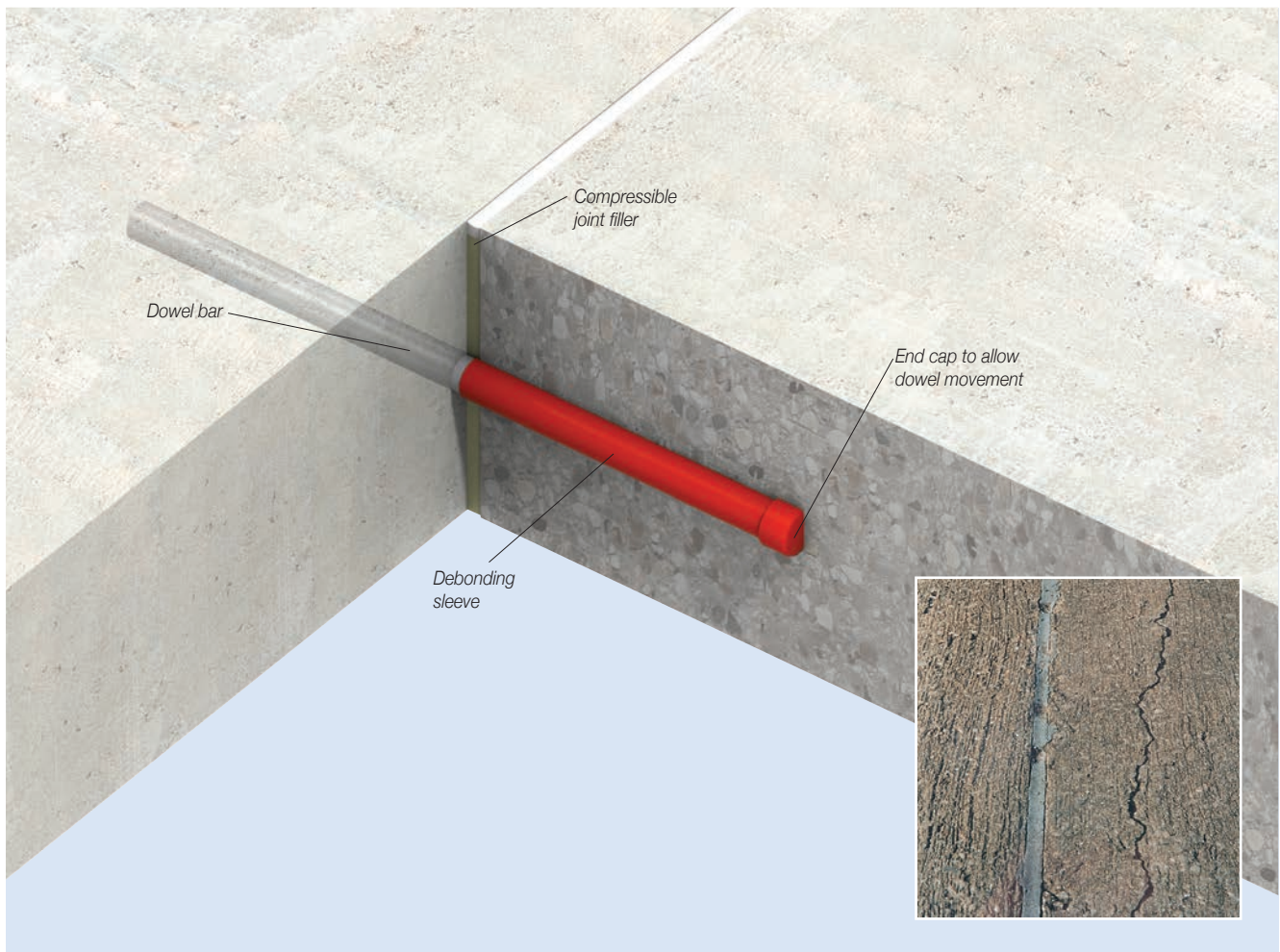
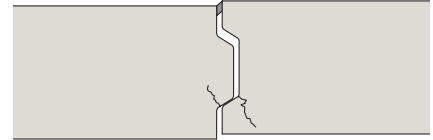

Misaligned dowels can result in cracking away from the expansion joint

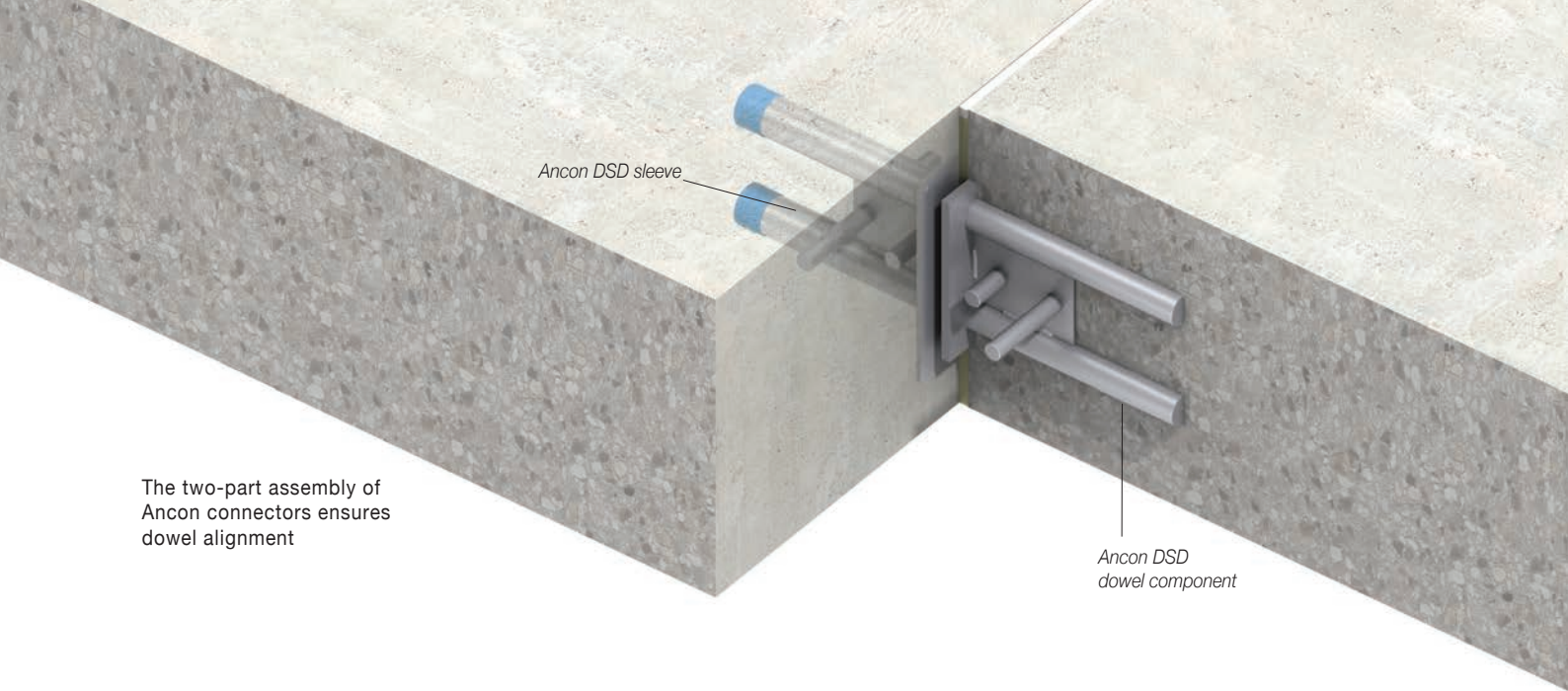

The two-part assembly of Ancon connectors ensures dowel alignment

### Conventional Joints Floor Slab

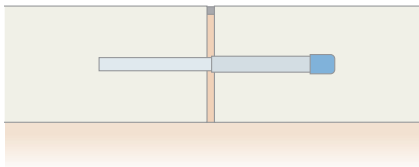

Dowel Bar

### Ancon Solutions

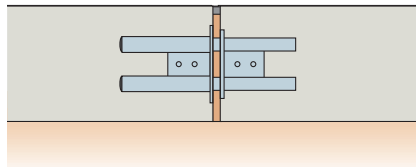

Ancon DSD

### Wall

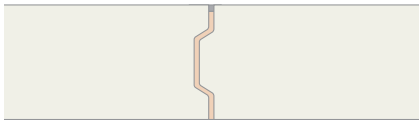

Keyed Joint

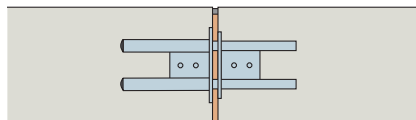

Ancon DSD

### Structural Movement Joint

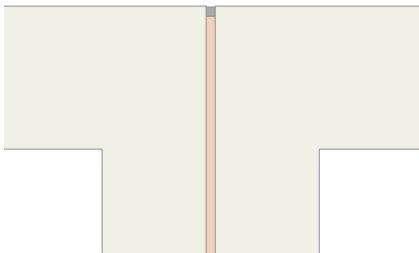

Double Columns

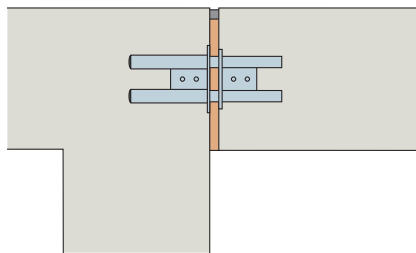

Ancon DSD

### Floor to Wall Connection

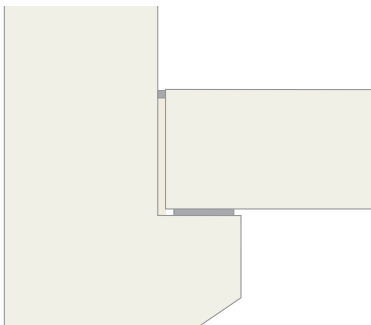

Corbel Support

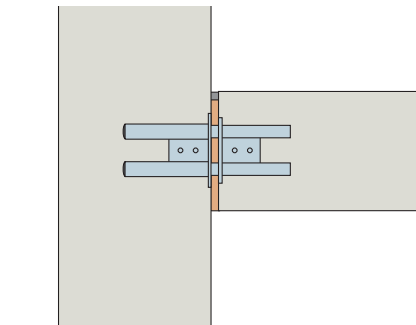

Ancon DSD

### Solutions to Joints

In most cases dowelled or keyed joints can be replaced by joints incorporating Ancon shear load connectors. These connectors are more effective at transferring load and allowing movement to take place, easier to fix on site and can prove a more cost-effective solution.

Ancon connectors can be used for movement joints in floor slabs, suspended slabs, and for replacing double columns and beams at structural movement joints. Applications in civil engineering include joints in bridge parapets, bridge abutments and diaphragm wall construction.

#### Comparison of Performance with Plain Dowels

400mm Thick Slab with Joint Width of 20mm	One Ancon DSD130	Six 22mm Dia Dowel Bars
Dowel Diameters mm	2 x 35	6 x 22
Area of Dowels mm <sup>2</sup>	1924	2281
Design Resistance kN	202.5	191.4

#### 1 Ancon DSD 130 Design Resistance 202.5kN

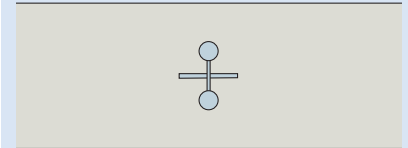

#### 6 Dowel Bars 22mm Diameter Design Resistance 191.4kN

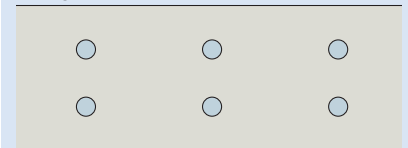



# DSD/ESD Shear Load Connectors

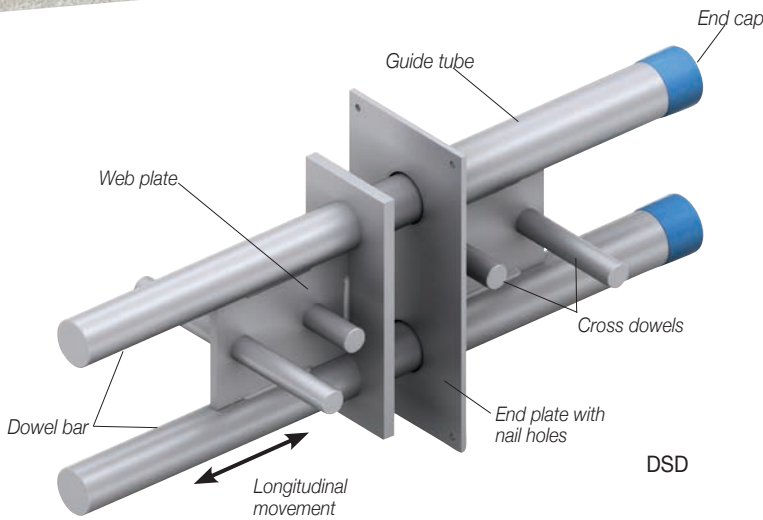

DSD

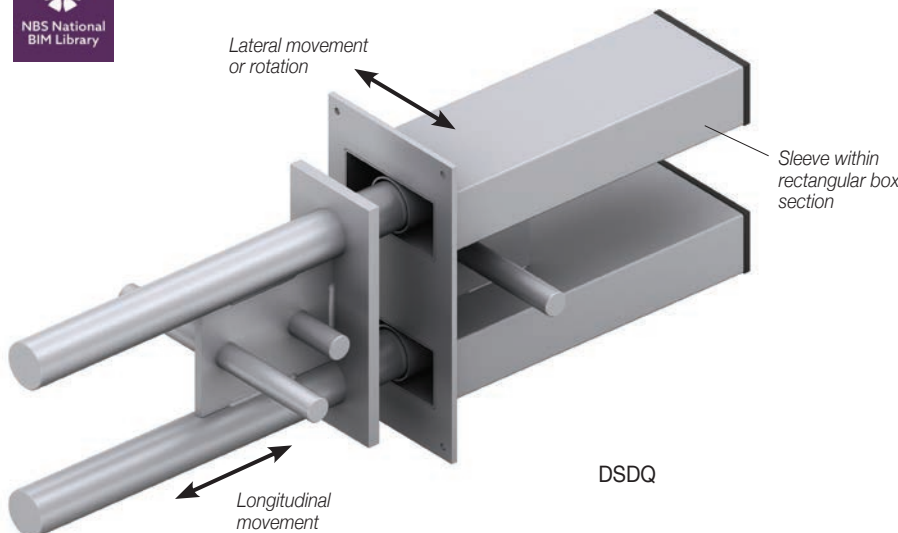

DSDQ



Ancon DSDQ Shear Connectors allowing rotation

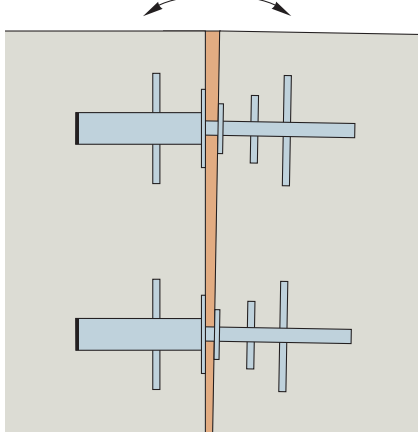

Plan

Ancon DSDQ Shear Connectors allowing movement in two directions

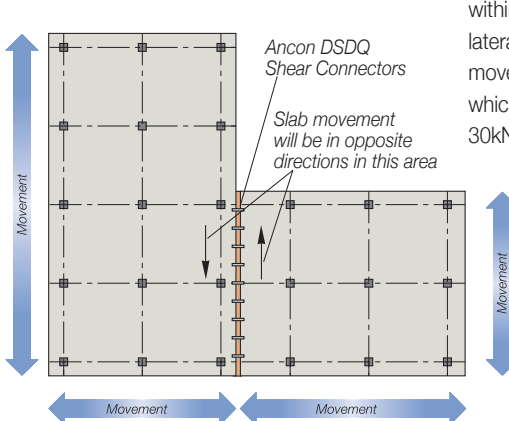

## Ancon Shear Load Connectors

The DSD range of connectors offers significant advantages over plain dowels. Each connector is a two-part assembly comprising a sleeve and a dowel component. Installation is a fast and accurate process, drilling of either formwork or concrete is not required. The sleeve is simply nailed to the formwork ensuring subsequent alignment with the dowel, essential for effective movement.

They are manufactured from stainless steel to ensure a high degree of corrosion resistance with no requirement for additional protection.

Free software is available from us, which simplifies the design of movement joints in reinforced concrete. For a given application, Our design program will calculate the size and quantity of shear load connectors required, the edge distance and spacings at which they should be installed, and details of the local reinforcement.

### Ancon DSD

The Ancon DSD is the original two-part, double dowel, shear load connector. The two dowels are Duplex stainless steel bar. The dowel component can move longitudinally within the sleeve to accommodate movement. The connector is available in ten standard sizes and has design resistances from around 20kN to over 950kN. The larger connectors can be used in joints up to 60mm wide. Larger joints can be accommodated using special dowels. Please contact Leviat's Technical Department for further information.

### Ancon DSDQ

The Ancon DSDQ shear load connector uses the same dowel component as the Ancon DSD, but the cylindrical sleeve is contained within a rectangular box section to allow lateral movement in addition to the longitudinal movement. There are nine standard sizes which have design resistances from around 30kN to over 950kN.

## Building Information Modelling

BIM objects of the Ancon DSD and DSDQ are available from [www.ancon.co.uk/BIM](http://www.ancon.co.uk/BIM)







A range of stainless steel single dowel shear connectors is also available.

**Ancon ESD**

The Ancon ESD shear load connector is used where loads are small, but where alignment is critical. It is available in four sizes with each size available in two lengths. The dowel component is Duplex stainless steel bar.



ESD

**Ancon ESDQ**

The Ancon ESDQ shear load connector uses the same dowel as the ESD, but the cylindrical sleeve is contained within a rectangular box section to allow lateral movement or rotation in addition to longitudinal movement.



ESDQ

**Ancon ED**

The Ancon ED is a low cost dowel connector for use in floor slabs where alignment is important but loads are small. The single dowel shear connector is available in four sizes with each size available in two lengths. The sleeve component is made from a durable plastic and features an integral nail plate. The dowel component is Duplex stainless steel.



ED

**Ancon Staisil-HLD Acoustic Dowel**

The Ancon Staisil-HLD features a 22mm diameter stainless steel dowel, located in a sound absorbing sleeve. It is designed to reduce the oscillation of impact sound through a building by isolating concrete components, such as stair landings from the main structural frame. A decoupled concrete configuration, featuring Staisil-HLDs, offers an 18dB impact sound reduction over a rigid concrete floor connection, verified by the Fraunhofer Institute.



Staisil-HLD

**Ancon HLD/HLDQ**

The Ancon HLD is a two-part, high load, shear connector for thinner slabs outside the application of the DSD range. The connector is available in seven sizes with design resistances from 24kN to over 500kN. The larger connectors can be used in joints up to 60mm wide.

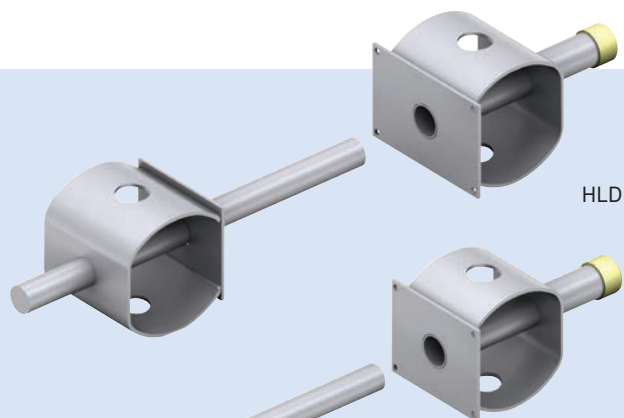

HLD

**Ancon E-HLD**

The Ancon E-HLD joins new concrete slabs to existing concrete walls and comprises a stainless steel dowel and a high strength, stainless steel sleeve. It is designed to transfer shear load where new slabs are connected to diaphragm walls or secant pile walls in basement construction. The dowel component is resin-fixed into the wall. It is available in seven standard sizes and can be used in a slab thickness from 160mm and joints up to 60mm wide.

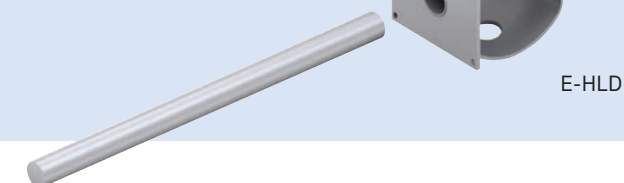

E-HLD

# DSD/ESD Shear Load Connectors

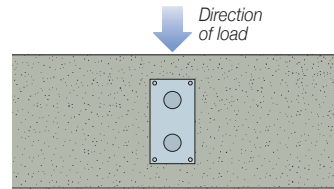

## Installation Procedure

The two-part assembly of all Ancon shear connectors removes the need for drilling formwork on site, supporting dowel bars and fitting debonding sleeves and end caps. The installation is a fast and accurate process.

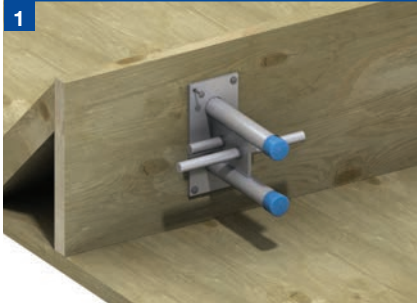

Nail the sleeve component to the shuttering ensuring that the sleeve is correctly orientated for the direction of the load. Check that the minimum spacing and edge distances are not exceeded. The label prevents debris from entering into the sleeve aperture and should not be removed at this stage.

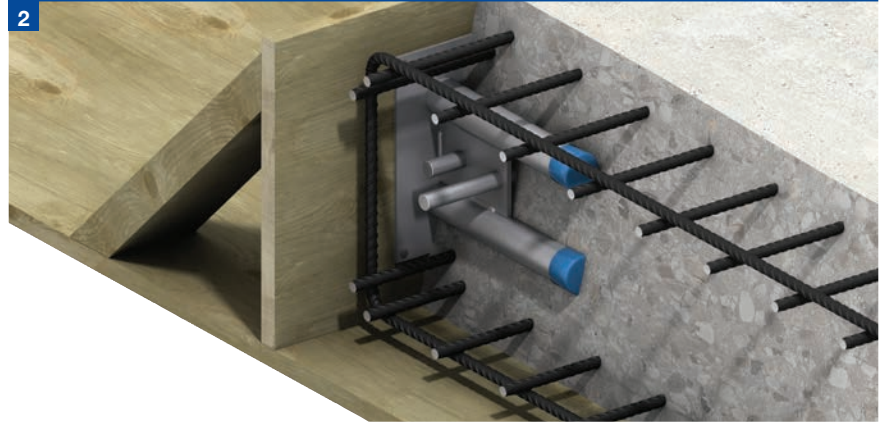

Fix the local reinforcement in position around the sleeve component together with any other reinforcement that is required, ensuring that the correct cover to the reinforcement is maintained. Pour the concrete to complete the installation of the sleeve component.



When the concrete has achieved sufficient strength, strike the shuttering. Peel off or puncture the label to reveal the holes for the dowels. Where 'Q' versions are being used, the label should only be punctured enough to allow the dowel into the cylindrical sleeve to prevent debris entering the box section.



Position compressible joint filler of the appropriate width, for applications where movement is expected between the two sections of concrete.



Push the dowel component through the joint filler (if applicable) until it is fully located in the sleeve component. It may be necessary to tap the dowel component to overcome the dimple which pinch holds the dowel in the sleeve and prevents dislocation when the concrete is vibrated.

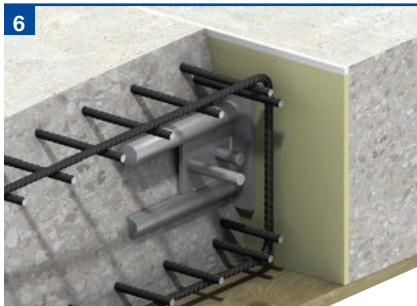

Fix the local reinforcement in position around the dowel component together with any other reinforcement that is required, ensuring that the correct cover to the reinforcement is maintained. Pour the concrete to complete the installation of the shear connector.

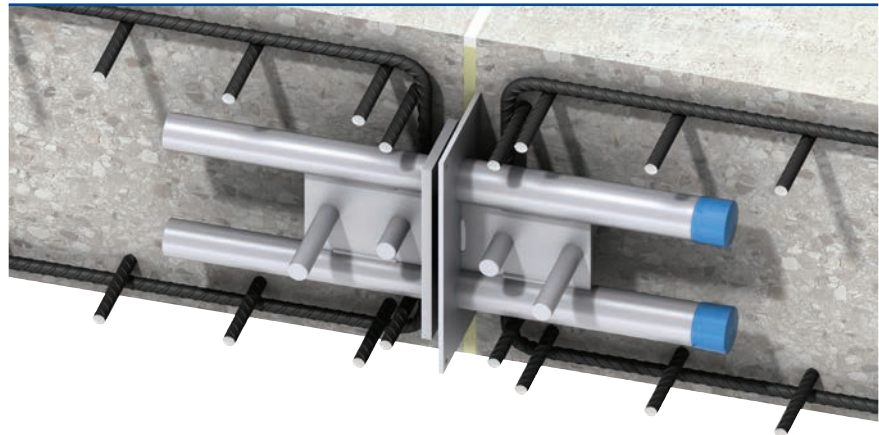

### Notes:

- (i) Although installation is shown for Ancon DSD, the procedure is the same for all Ancon shear connectors.
- (ii) Where deep concrete pours are proposed, the installation will require further consideration. More robust fixing of the sleeve and dowel components will be necessary to avoid displacement during placing of the concrete.



## Design Resistance

Ancon DSD  $V_{Rd}$  Design Resistance (kN) for Various Joint Widths (mm) at the Maximum Slab Thickness (mm) in C30/37 Concrete

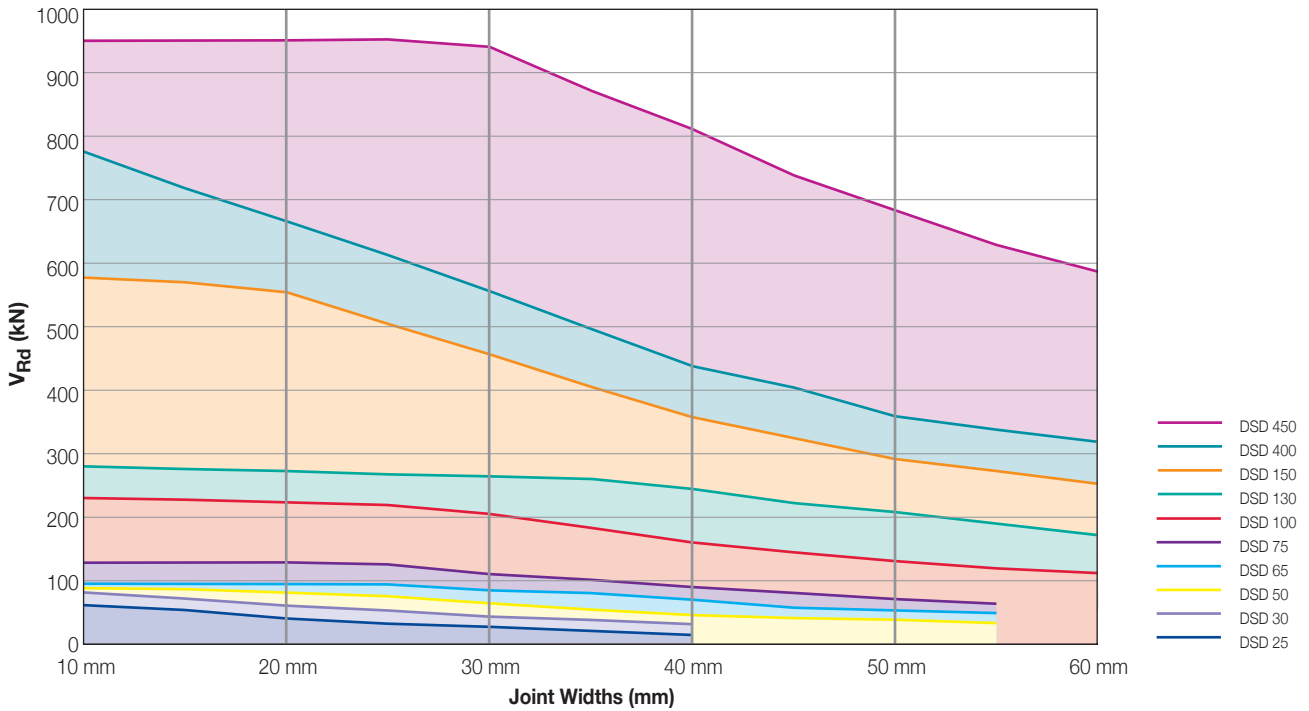

Note: For more detailed information please see page 11.

Ancon ESD  $V_{Rd}$  Design Resistance (kN) for Various Joint Widths (mm) at the Maximum Slab Thickness (mm) in C30/37 Concrete

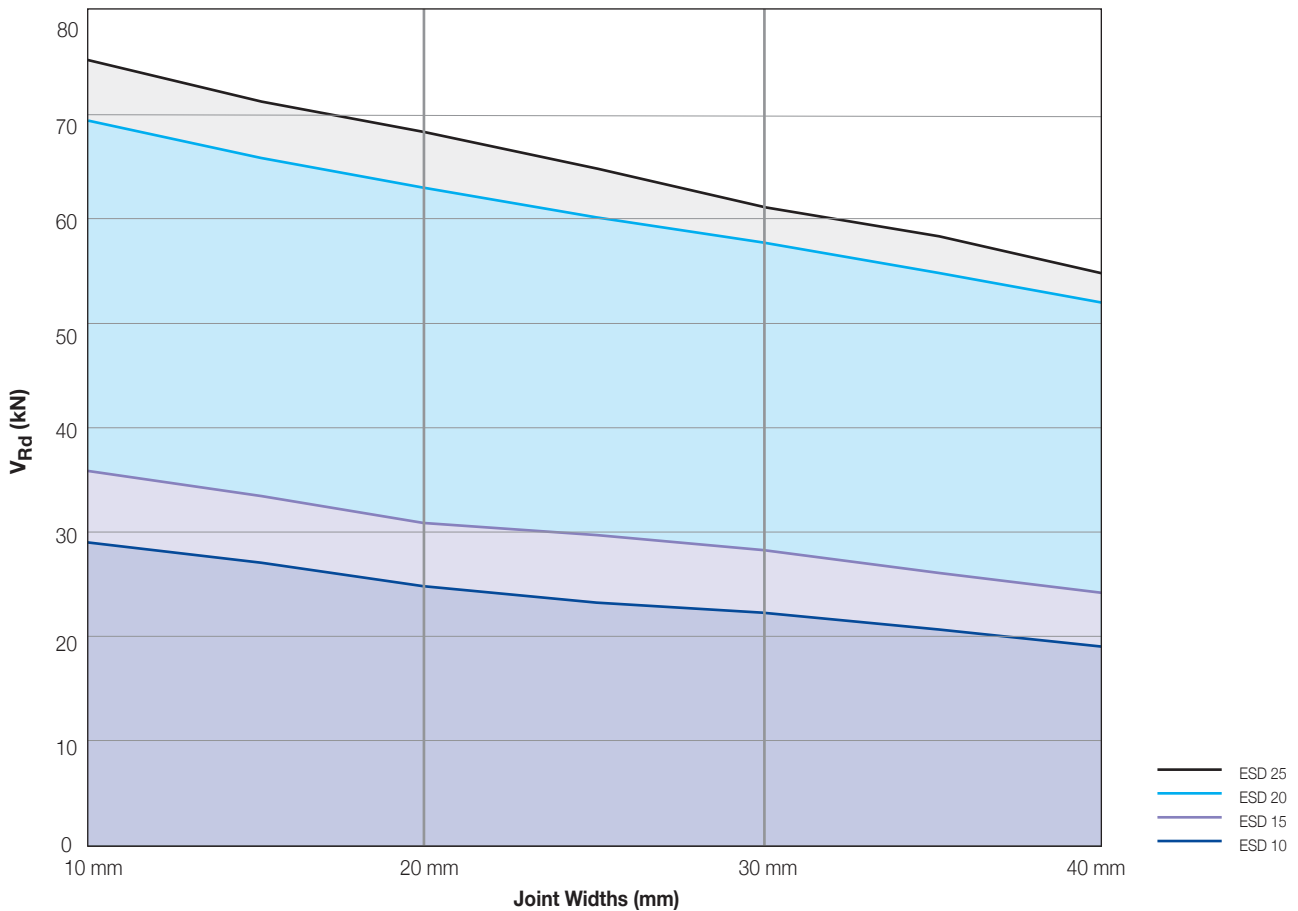

Note: For more detailed information please see page 17.



# DSD/ESD Shear Load Connectors

## DSD and DSDQ Shear Connectors

$V_{Rd}$  Design Resistance (kN) for Various Joint Widths (mm) and Slab Thickness (mm) using C25/30 Concrete

Slab Thickness (mm)	Product Reference	Maximum Width of Joint (mm)					
		10	20	30	40	50	60
180*	DSD 25	39.5	39.5	29.9	23.2	-	-
200		45.7	41.8	29.9	23.2	-	-
220		52.3	41.8	29.9	23.2	-	-
240		59.3	41.8	29.9	23.2	-	-
260		66.7	41.8	29.9	23.2	-	-
280		69.6	41.8	29.9	23.2	-	-
180*	DSD/DSDQ 30	42.7	42.7	42.7	34.7	-	-
200		49.2	49.2	44.6	34.7	-	-
220		56.1	56.1	44.6	34.7	-	-
240		63.4	62.4	44.6	34.7	-	-
260		71.1	62.4	44.6	34.7	-	-
280		79.1	62.4	44.6	34.7	-	-
180*	DSD/DSDQ 50	43.8	43.8	43.8	43.8	40.4	-
200		50.3	50.3	50.3	49.4	40.4	-
220		57.3	57.3	57.3	49.4	40.4	-
240		64.6	64.6	63.5	49.4	40.4	-
260		72.3	72.3	63.5	49.4	40.4	-
280		80.4	80.4	63.5	49.4	40.4	-
200*	DSD/DSDQ 65	62.2	62.2	62.2	62.2	55.4	-
220		64.3	64.3	64.3	64.3	55.4	-
240		68.6	68.6	68.6	67.7	55.4	-
260		76.4	76.4	76.4	67.7	55.4	-
280		84.6	84.6	84.6	67.7	55.4	-
300		93.0	93.0	87.1	67.7	55.4	-
240*	DSD/DSDQ 75	86.1	86.1	86.1	86.1	73.8	-
260		89.1	89.1	89.1	89.1	73.8	-
280		94.8	94.8	94.8	90.1	73.8	-
300		104.0	104.0	104.0	90.1	73.8	-
320		113.6	113.6	113.6	90.1	73.8	-
340		123.4	123.4	115.9	90.1	73.8	-
320*	DSD/DSDQ 100	161.5	157.6	154.0	150.5	133.6	114.0
340		166.5	162.6	158.8	155.2	133.6	114.0
360		170.8	166.7	162.8	159.1	133.6	114.0
380		183.2	178.9	174.7	161.4	133.6	114.0
400		196.0	191.4	186.9	161.4	133.6	114.0
420		209.1	204.2	199.4	161.4	133.6	114.0
360*	DSD/DSDQ 130	185.0	181.3	177.7	174.3	171.0	167.9
380		193.4	189.5	185.8	182.2	178.8	175.5
400		206.6	202.5	198.5	194.7	191.0	176.1
420		220.2	215.8	211.5	207.5	203.6	176.1
440		234.0	229.3	224.8	220.5	206.5	176.1
460		248.2	243.2	238.4	233.8	206.5	176.1
450*	DSD/DSDQ 150	280.8	276.0	271.3	266.8	262.4	253.6
500		308.2	302.8	297.7	292.8	288.0	253.6
550		339.7	333.8	328.2	322.7	297.4	253.6
600		380.5	373.9	367.6	359.3	297.4	253.6
700		465.4	457.3	449.6	359.3	297.4	253.6
800		485.6	477.2	451.2	359.3	297.4	253.6
600*	DSD/DSDQ 400	441.1	434.6	428.3	422.2	369.3	315.0
650		485.1	478.0	471.0	441.8	369.3	315.0
700		529.9	522.1	514.5	441.8	369.3	315.0
800		620.9	611.8	554.1	441.8	369.3	315.0
900		712.7	666.4	554.1	441.8	369.3	315.0
1000		745.3	666.4	554.1	441.8	369.3	315.0
600*	DSD/DSDQ 450	485.1	485.1	485.1	485.1	485.1	485.1
650		515.5	515.5	515.5	515.5	515.5	515.5
700		561.4	561.4	561.4	561.4	561.4	561.4
800		654.4	654.4	654.4	654.4	654.4	586.9
900		747.9	747.9	747.9	747.9	684.7	586.9
1000		840.1	840.1	840.1	811.4	684.7	586.9

\* Refers to the minimum slab depth  $H_{min}$  for each connector type.

### Position of connectors in slab

The tables on pages 10 and 11 are based on the shear connector being located centrally in the slab edge. If the shear connector is offset from the centreline, the minimum distance between the connector centre and the slab face should be considered as  $H/2$ .

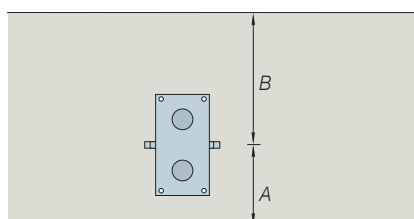

$A < B$   
Slab thickness to be considered in selecting the connector is  $2 \times A$ . Minimum values are shown in the table.

Product Reference	Minimum Slab Depth $H_{min}$	Minimum Depth 'A'
DSD 25	180mm	90mm
DSD/DSDQ 30	180mm	90mm
DSD/DSDQ 50	180mm	90mm
DSD/DSDQ 65	200mm	100mm
DSD/DSDQ 75	240mm	120mm
DSD/DSDQ 100	320mm	160mm
DSD/DSDQ 130	360mm	180mm
DSD/DSDQ 150	450mm	225mm
DSD/DSDQ 400	600mm	300mm
DSD/DSDQ 450	600mm	300mm

**V<sub>Rd</sub> Design Resistance (kN) for Various Joint Widths (mm) and Slab Thickness (mm) using C30/37 Concrete**

Slab Thickness (mm)	Product Reference	Maximum Width of Joint (mm)					
		10	20	30	40	50	60
180*	DSD 25	44.7	41.8	29.9	23.2	-	-
200		51.8	41.8	29.9	23.2	-	-
220		59.3	41.8	29.9	23.2	-	-
240		67.3	41.8	29.9	23.2	-	-
260		69.6	41.8	29.9	23.2	-	-
280		69.6	41.8	29.9	23.2	-	-
180*	DSD/DSDQ 30	48.3	48.3	44.6	34.7	-	-
200		55.7	55.7	44.6	34.7	-	-
220		63.6	62.4	44.6	34.7	-	-
240		71.8	62.4	44.6	34.7	-	-
260		80.5	62.4	44.6	34.7	-	-
280		89.7	62.4	44.6	34.7	-	-
180*	DSD/DSDQ 50	49.6	49.6	49.6	49.4	40.4	-
200		57.0	57.0	57.0	49.4	40.4	-
220		64.9	64.9	63.5	49.4	40.4	-
240		73.2	73.2	63.5	49.4	40.4	-
260		82.0	82.0	63.5	49.4	40.4	-
280		91.1	88.9	63.5	49.4	40.4	-
200*	DSD/DSDQ 65	70.5	70.5	70.5	67.7	55.4	-
220		72.8	72.8	72.8	67.7	55.4	-
240		77.8	77.8	77.8	67.7	55.4	-
260		86.6	86.6	86.6	67.7	55.4	-
280		95.8	95.8	87.1	67.7	55.4	-
300		105.5	105.5	87.1	67.7	55.4	-
240*	DSD/DSDQ 75	97.6	97.6	97.6	90.1	73.8	-
260		101.0	101.0	101.0	90.1	73.8	-
280		107.4	107.4	107.4	90.1	73.8	-
300		117.9	117.9	115.9	90.1	73.8	-
320		128.7	128.7	115.9	90.1	73.8	-
340		139.9	139.9	115.9	90.1	73.8	-
320*	DSD/DSDQ 100	183.0	178.7	174.5	161.4	133.6	114.0
340		188.7	184.3	180.0	161.4	133.6	114.0
360		193.5	188.9	184.5	161.4	133.6	114.0
380		207.7	202.7	198.0	161.4	133.6	114.0
400		222.2	216.9	203.9	161.4	133.6	114.0
420		237.0	231.4	203.9	161.4	133.6	114.0
360*	DSD/DSDQ 130	209.7	205.5	201.4	197.6	193.8	176.1
380		219.2	214.8	210.6	206.5	202.7	176.1
400		234.2	229.5	225.0	220.7	206.5	176.1
420		249.5	244.5	239.8	235.1	206.5	176.1
440		265.2	259.9	254.8	249.5	206.5	176.1
460		281.2	275.6	270.2	249.5	206.5	176.1
450*	DSD/DSDQ 150	318.2	312.8	307.5	302.3	297.4	253.6
500		349.2	343.2	337.4	331.8	297.4	253.6
550		385.0	378.3	371.9	359.3	297.4	253.6
600		431.2	423.8	416.6	359.3	297.4	253.6
700		527.4	518.3	451.2	359.3	297.4	253.6
800		582.7	553.0	451.2	359.3	297.4	253.6
600*	DSD/DSDQ 400	499.9	492.5	485.4	441.8	369.3	315.0
650		549.8	541.7	533.8	441.8	369.3	315.0
700		600.5	591.7	554.1	441.8	369.3	315.0
800		703.7	666.4	554.1	441.8	369.3	315.0
900		778.7	666.4	554.1	441.8	369.3	315.0
1000		778.7	666.4	554.1	441.8	369.3	315.0
600*	DSD/DSDQ 450	549.8	549.8	549.8	549.8	549.8	549.8
650		584.2	584.2	584.2	584.2	584.2	584.2
700		636.2	636.2	636.2	636.2	636.2	586.9
800		741.7	741.7	741.7	741.7	684.7	586.9
900		847.6	847.6	847.6	811.4	684.7	586.9
1000	952.1	952.1	941.1	811.4	684.7	586.9	

\* Refers to the minimum slab depth H<sub>min</sub> for each connector type.

**DSD Design Example**

Slab thickness	= 400mm	
Maximum width of joint	= 30mm	
Concrete strength	= C30/37	
Characteristic dead load	= 100kN/m	γ <sub>G</sub> = 1.35*
Characteristic imposed load	= 120kN/m	γ <sub>Q</sub> = 1.5*
Design load	= (100 x 1.35) + (120 x 1.5) = 315kN/m	

V <sub>Rd</sub> (Design resistance)	Maximum centres	Either connector would be acceptable, although
DSD100 = 203.9kN	= 203.9 / 315 = 0.647m use 600mm	using DSD130s at 700mm centres would minimise
DSD130 = 225.0kN	= 225.0 / 315 = 0.714m use 700mm	the number of connectors to be installed.

\*The partial safety factors of 1.35 (γ<sub>G</sub>) and 1.5 (γ<sub>Q</sub>) are those recommended in EN 1990 Eurocode: Basis for structural design. For designs to Eurocode 2, please refer to the national annex for the factors to be used in the country concerned.

See local reinforcement requirements on page 12.

# DSD/ESD Shear Load Connectors

## DSD Reinforcement Details

Local reinforcement is required around each connector to guarantee that the forces are transferred between the connectors and the concrete. Correct detailing in accordance with appropriate design codes and the recommendations provided here will ensure Ancon DSD and DSDQ connectors attain their full capacity.

The tables show proposals for the type and spacing of the main reinforcement, together with details of reinforcement above and below the connectors.

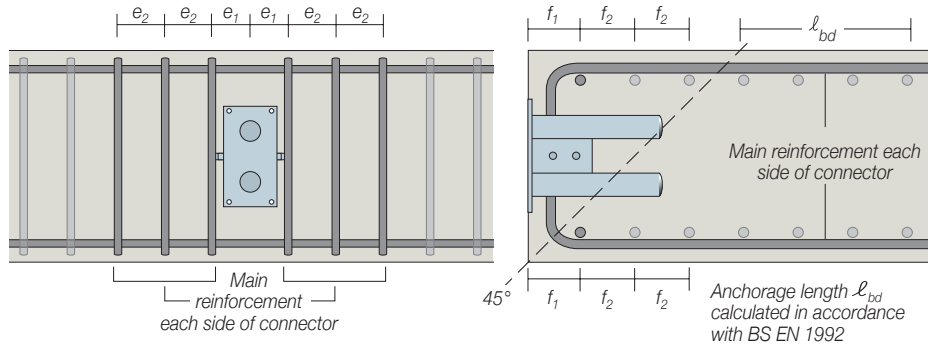

Based on C25/30 Concrete, maximum slab depth (see page 10), 20mm joint and 30mm cover

DSD/DSDQ	Options for Main Reinforcement (No. U bars each side)	Spacing (mm)
25*	2 H10	$e_1 = 50\text{mm}; e_2 = 98\text{mm}$
30	3 H10	$e_1 = 50\text{mm}; e_2 = 52\text{mm}$
	2 H12	$e_1 = 50\text{mm}; e_2 = 95\text{mm}$
50	4 H10	$e_1 = 50\text{mm}; e_2 = 35\text{mm}$
	3 H12	$e_1 = 50\text{mm}; e_2 = 48\text{mm}$
65	4 H10	$e_1 = 60\text{mm}; e_2 = 40\text{mm}$
	3 H12	$e_1 = 60\text{mm}; e_2 = 56\text{mm}$
75	5 H10	$e_1 = 60\text{mm}; e_2 = 39\text{mm}$
	4 H12	$e_1 = 60\text{mm}; e_2 = 50\text{mm}$
100	5 H12	$e_1 = 60\text{mm}; e_2 = 57\text{mm}$
	3 H16	$e_1 = 60\text{mm}; e_2 = 116\text{mm}$
130	4 H16	$e_1 = 60\text{mm}; e_2 = 84\text{mm}$
150	6 H16	$e_1 = 60\text{mm}; e_2 = 101\text{mm}$
400	7 H16	$e_1 = 60\text{mm}; e_2 = 114\text{mm}$
450	9 H16	$e_1 = 60\text{mm}; e_2 = 87\text{mm}$

DSD/DSDQ	Options for Longitudinal Bars (No. bars top and bottom)	Spacing (mm)
25*	1 H10	$f_1 = 60\text{mm}$
30	2 H10	$f_1 = 60\text{mm}; f_2 = 60\text{mm}$
50	2 H10	$f_1 = 60\text{mm}; f_2 = 70\text{mm}$
	2 H12	$f_1 = 60\text{mm}; f_2 = 70\text{mm}$
65	2 H10	$f_1 = 60\text{mm}; f_2 = 70\text{mm}$
	2 H12	$f_1 = 60\text{mm}; f_2 = 70\text{mm}$
75	3 H10	$f_1 = 60\text{mm}; f_2 = 70\text{mm}$
	2 H12	$f_1 = 60\text{mm}; f_2 = 70\text{mm}$
100	3 H12	$f_1 = 60\text{mm}; f_2 = 70\text{mm}$
	2 H16	$f_1 = 60\text{mm}; f_2 = 70\text{mm}$
130	3 H12	$f_1 = 60\text{mm}; f_2 = 70\text{mm}$
	2 H16	$f_1 = 60\text{mm}; f_2 = 70\text{mm}$
150	4 H16	$f_1 = 60\text{mm}; f_2 = 70\text{mm}$
400	5 H16	$f_1 = 60\text{mm}; f_2 = 100\text{mm}$
450	6 H16	$f_1 = 60\text{mm}; f_2 = 100\text{mm}$

Based on C30/37 Concrete, maximum slab depth (see page 11) 20mm joint and 30mm cover

DSD/DSDQ	Options for Main Reinforcement (No. U bars each side)	Spacing (mm)
25*	2 H10	$e_1 = 50\text{mm}; e_2 = 98\text{mm}$
30	3 H10	$e_1 = 50\text{mm}; e_2 = 52\text{mm}$
	2 H12	$e_1 = 50\text{mm}; e_2 = 95\text{mm}$
50	4 H10	$e_1 = 50\text{mm}; e_2 = 35\text{mm}$
	3 H12	$e_1 = 50\text{mm}; e_2 = 48\text{mm}$
65	4 H10	$e_1 = 60\text{mm}; e_2 = 40\text{mm}$
	3 H12	$e_1 = 60\text{mm}; e_2 = 56\text{mm}$
75	5 H10	$e_1 = 60\text{mm}; e_2 = 39\text{mm}$
	4 H12	$e_1 = 60\text{mm}; e_2 = 50\text{mm}$
100	5 H12	$e_1 = 60\text{mm}; e_2 = 45\text{mm}$
	3 H16	$e_1 = 60\text{mm}; e_2 = 70\text{mm}$
130	4 H16	$e_1 = 60\text{mm}; e_2 = 81\text{mm}$
150	6 H16	$e_1 = 60\text{mm}; e_2 = 101\text{mm}$
400	7 H16	$e_1 = 60\text{mm}; e_2 = 114\text{mm}$
450	9 H16	$e_1 = 60\text{mm}; e_2 = 87\text{mm}$

DSD/DSDQ	Options for Longitudinal Bars (No. bars top and bottom)	Spacing (mm)
25*	1 H10	$f_1 = 60\text{mm}$
30	2 H10	$f_1 = 60\text{mm}; f_2 = 60\text{mm}$
50	2 H10	$f_1 = 60\text{mm}; f_2 = 70\text{mm}$
	2 H12	$f_1 = 60\text{mm}; f_2 = 70\text{mm}$
65	2 H10	$f_1 = 60\text{mm}; f_2 = 70\text{mm}$
	2 H12	$f_1 = 60\text{mm}; f_2 = 70\text{mm}$
75	3 H10	$f_1 = 60\text{mm}; f_2 = 70\text{mm}$
	2 H12	$f_1 = 60\text{mm}; f_2 = 70\text{mm}$
100	3 H12	$f_1 = 60\text{mm}; f_2 = 70\text{mm}$
	2 H16	$f_1 = 60\text{mm}; f_2 = 70\text{mm}$
130	4 H12	$f_1 = 60\text{mm}; f_2 = 70\text{mm}$
	2 H16	$f_1 = 60\text{mm}; f_2 = 70\text{mm}$
150	4 H16	$f_1 = 60\text{mm}; f_2 = 70\text{mm}$
400	5 H16	$f_1 = 60\text{mm}; f_2 = 100\text{mm}$
450	6 H16	$f_1 = 60\text{mm}; f_2 = 100\text{mm}$

\*DSD only

For walls, the reinforcement is repeated as in the tables but with links replacing the U-bars. Links should extend between the near face and the far face of the wall reinforcement.

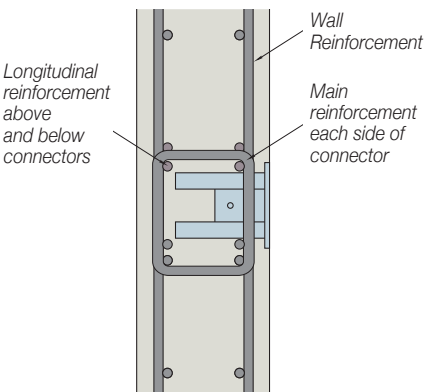



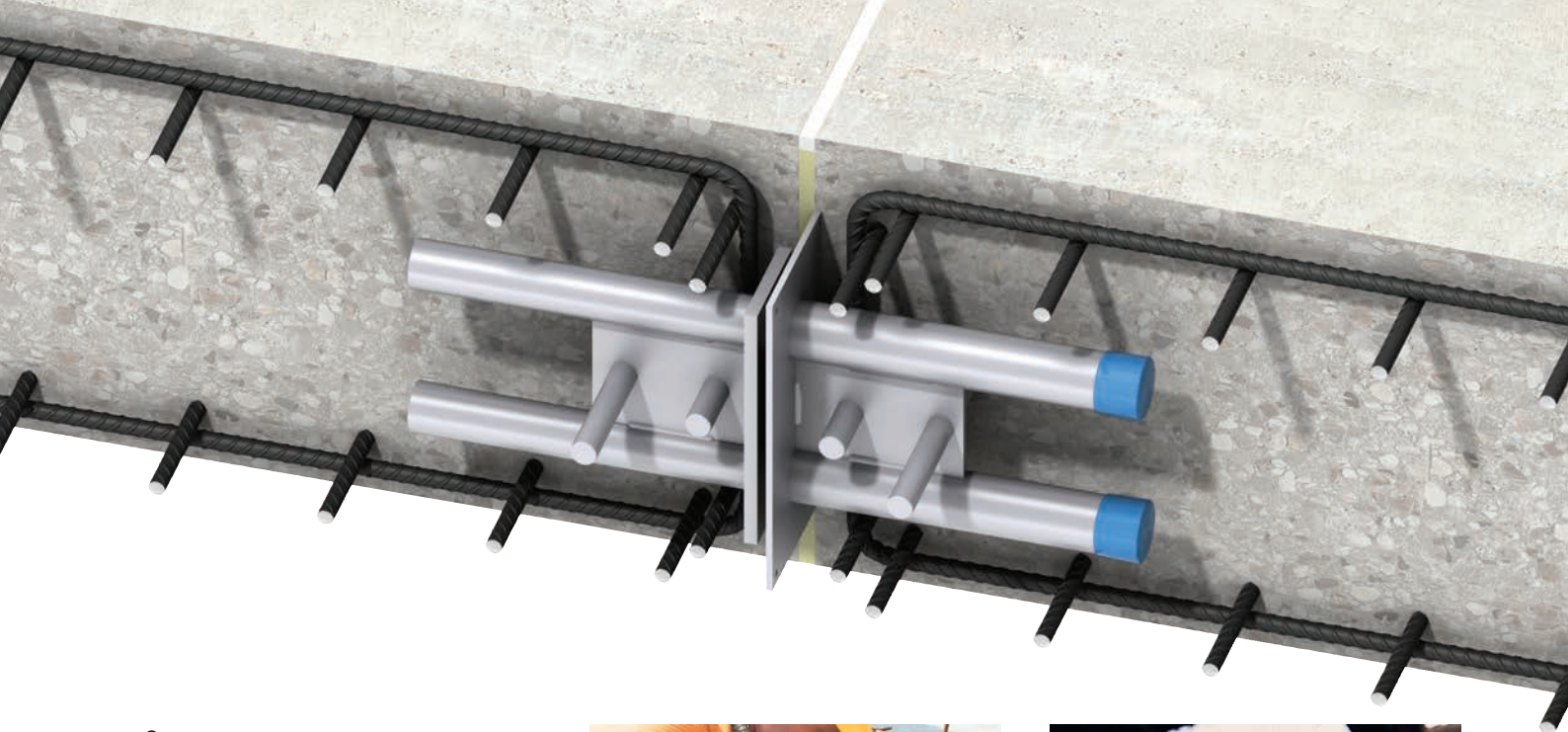

### Cover

Minimum cover  $C_U$  to local reinforcement is to the recommendations of BS EN 1992.

Maximum cover  $C_f$  to face of slab is as shown below:

Ref DSD	Max Cover to Face $C_f$ (mm)	Ref DSDQ	Max Cover to Face $C_f$ (mm)
25	40	-	-
30	40	30	40
50	40	50	40
65	40	65	40
75	40	75	40
100	50	100	65
130	50	130	70
150	70	150	70
400	80	400	80
450	50	450	50

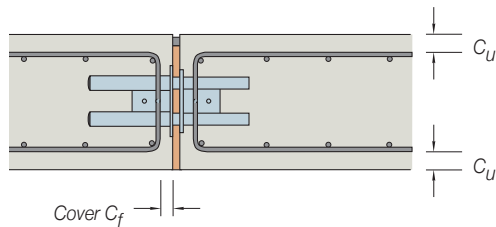

### Minimum Wall Thickness

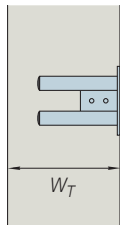

Ref DSD/DSDQ	Minimum Wall Thickness $W_T$ DSD	DSDQ
25	180mm	-
30	180mm	190mm
50	185mm	210mm
65	205mm	225mm
75	205mm	225mm
100	260mm	290mm
130	315mm	340mm
150	325mm	355mm
400	385mm	405mm
450	420mm	455mm

### Guidance on Specifying DSD at Beam Connections

The diagram and table show the minimum vertical and horizontal spacings. For further guidance, and local reinforcement requirements, please contact us.

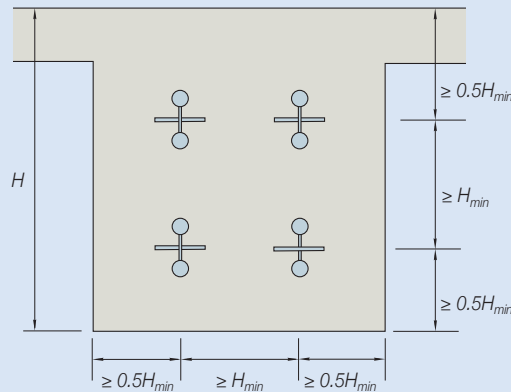

#### Minimum Dowel Centres

DSD Type	$H_{min}$
DSD25	180mm
DSD30	180mm
DSD50	180mm
DSD65	200mm
DSD75	240mm
DSD100	320mm
DSD130	360mm
DSD150	450mm
DSD400	600mm
DSD450	600mm

# DSD/ESD Shear Load Connectors



## Material Specifications

Dowel Bars: 1.4462 to BS EN 10088  
 Other Metal Components: 1.4301 to BS EN 10088  
 Plastic Sleeve: Polypropylene, CnH2n

## Dowel Component

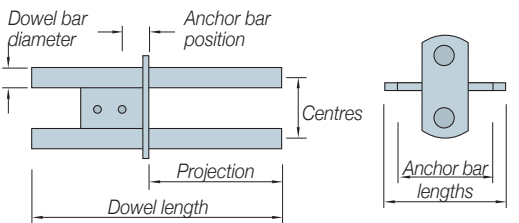

## DSD Sleeve

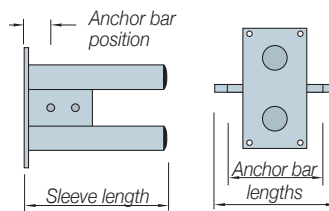

## DSDQ Sleeve

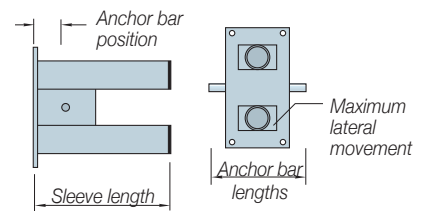

## Dimensions

Ref DSD DSDQ	Dowel Component						DSD Sleeve			DSDQ Sleeve			
	Overall Length	Dowel Dia	Dowel Centres	Dowel Projection	Anchor Bar Position	Anchor Bar Lengths	Overall Length	Anchor Bar Position	Anchor Bar Lengths	Overall Length	Anchor Bar Position	Anchor Bar Length	Lateral Mov't
25*	250	14	40	120	31	50/110	120	28	50/110	-	-	-	-
30	260	16	48	120	31	50/110	120	28	50/110	140	33	70	+/-12.5
50	280	18	50	130	31	50/130	135	28	50/130	160	33	70	+/-12.8
65	300	20	65	150	31	50/130	155	28	50/130	175	33	70	+/-10.5
75	340	22	75	150	33	50/150	155	31	50/150	175	33	120	+/-10.3
100	400	30	100	210	34	80/170	210	36	80/170	240	54	170	+/-20.75
130	470	35	105	260	34	80/170	265	36	80/170	290	59	170	+/-18.25
150	550	42	120	270	54	80/210	275	39	80/210	305	54	170	+/-10.85
400	660	52	160	330	70	130/300	335	70	130/300	355	64	300	+/-15.25
450	690	65	180	360	80	130/300	370	80	130/300	400	89	300	+/-27.5

Notes: \*DSD only. All dimensions are in millimetres (mm).

## Edge Distance and Spacing

The minimum edge distance and spacing of Ancon DSD/DSDQ shear load connectors is determined by the depth of slab and is illustrated in the adjacent drawing. It is possible to reduce the spacing further with the absolute minimum being  $1.5 H_{\min}$  (where  $H_{\min}$  is the minimum slab depth for each connector type), however the design resistances are then limited to those given for  $H_{\min}$  only.

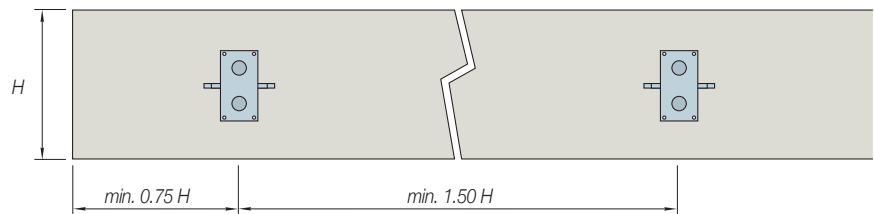

## Ancon ESD and ESDQ Shear Connectors

### Dowel Component

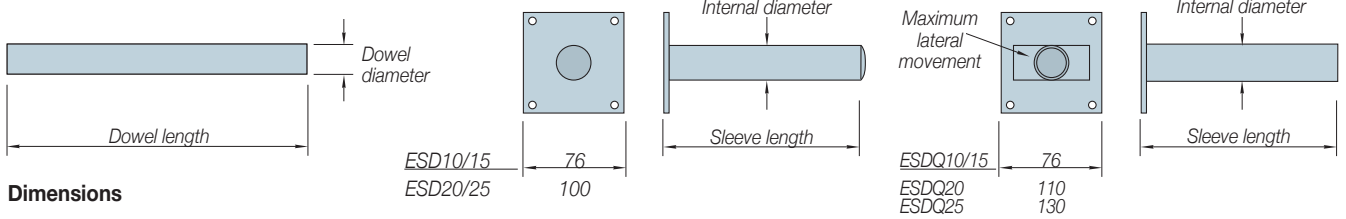

### Dimensions

Ref ESD ESDQ	Dowel Component		ESD Sleeve		ESDQ Sleeve		
	Dowel Diameter	Dowel Length	Internal Diameter	Sleeve Length	Internal Diameter	Sleeve Length	Max. Lateral Movement
10 300	20	300	21	170	21	170	+/-10
10 400	20	400	21	220	21	220	+/-10
15 300	22	300	23	170	23	170	+/-10
15 400	22	400	23	220	23	220	+/-10
20 300	30	300	31	170	31	170	+/-20
20 400	30	400	31	210	31	210	+/-20
25 350	35	350	36	195	36	195	+/-18
25 470	35	470	36	265	36	285	+/-18

Notes: Example Ref ESD10 300. All dimensions are in millimetres (mm).

## Ancon ED Shear Connectors

### Dowel Component

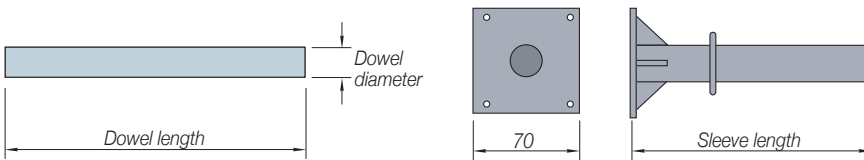

### Dimensions

Ref ED	Dowel Length	Dowel Diameter	Sleeve Length
10 300	300	20	170
10 400	400	20	220
15 300	300	22	170
15 400	400	22	220
20 300	300	30	170
20 400	400	30	220
25 350	350	35	195
25 470	470	35	260

### Edge Distance and Spacing

The minimum edge distance and spacing of Ancon ESD/ESDQ/ED shear load connectors is determined by the depth of slab and is illustrated in the adjacent drawing. It is possible to reduce the spacing further with the absolute minimum being  $1.5 H_{min}$  (where  $H_{min}$  is the minimum slab depth for each connector type), however the design resistances are then limited to those given for  $H_{min}$  only.

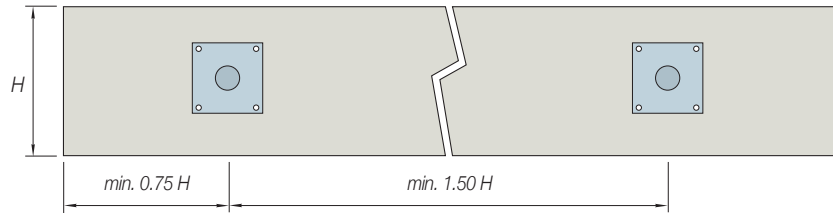

## Ancon Staisil-HLD Acoustic Shear Dowel

### Dowel Component

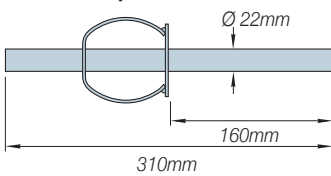

### Sleeve

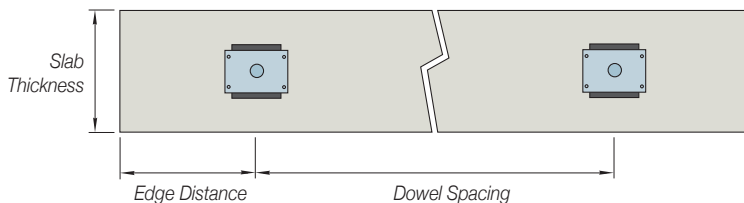
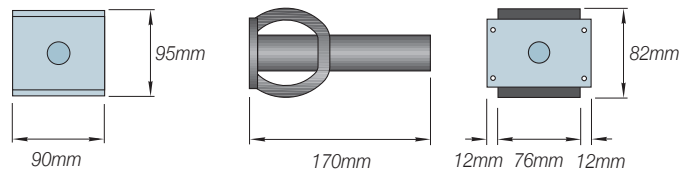

### Minimum Dowel Spacing

Slab Thickness (mm)	180	200	220	240	260	280	300	320
Minimum Edge Distance (mm)	180	180	180	175	175	175	175	175
Minimum Dowel Spacing (mm)	360	360	360	350	350	350	350	350



# DSD/ESD Shear Load Connectors

## $V_{Rd}$ Design Resistance (kN) for Various Joint Widths (mm) and Slab Thickness (mm) using C25/30 Concrete

Slab Thickness (mm)	Product Reference	Maximum Width of Joint (mm)			
		10	20	30	40
180*	ESD/ESDQ 10	25.6	25.6	22.4	19.7
200		26.7	25.7	22.4	19.7
220		26.7	25.7	22.4	19.7
240		26.7	25.7	22.4	19.7
260		26.7	25.7	22.4	19.7
280		26.7	25.7	22.4	19.7
180*	ESD/ESDQ 15	28.7	28.7	28.1	24.9
200		32.3	31.9	28.1	24.9
220		32.3	31.9	28.1	24.9
240		32.3	31.9	28.1	24.9
260		32.3	31.9	28.1	24.9
280		32.3	31.9	28.1	24.9
220*	ESD/ESDQ 20	47.3	47.3	47.3	47.3
240		54.9	54.9	54.9	52.7
260		60.0	60.0	57.8	52.7
280		60.0	60.0	57.8	52.7
300		60.0	60.0	57.8	52.7
350		60.0	60.0	57.8	52.7
240*	ESD/ESDQ 25	56.8	56.8	56.8	55.7
260		65.0	65.0	61.5	55.7
280		73.7	68.0	61.5	55.7
300		75.4	68.0	61.5	55.7
350		75.4	68.0	61.5	55.7
400		75.4	68.0	61.5	55.7

Slab Thickness (mm)	Product Reference	Maximum Width of Joint (mm)			
		10	20	30	40
180*	ED 10	25.6	25.6	22.4	19.7
200		26.7	25.7	22.4	19.7
220		26.7	25.7	22.4	19.7
240		26.7	25.7	22.4	19.7
260		26.7	25.7	22.4	19.7
280		26.7	25.7	22.4	19.7
180*	ED 15	28.7	28.7	28.1	24.9
200		32.3	31.9	28.1	24.9
220		32.3	31.9	28.1	24.9
240		32.3	31.9	28.1	24.9
260		32.3	31.9	28.1	24.9
280		32.3	31.9	28.1	24.9
220*	ED 20	47.3	47.3	47.3	47.3
240		54.9	54.9	54.9	52.7
260		60.0	60.0	57.8	52.7
280		60.0	60.0	57.8	52.7
300		60.0	60.0	57.8	52.7
350		60.0	60.0	57.8	52.7
240*	ED 25	56.8	56.8	56.8	55.7
260		65.0	65.0	61.5	55.7
280		73.7	68.0	61.5	55.7
300		75.4	68.0	61.5	55.7
350		75.4	68.0	61.5	55.7
400		75.4	68.0	61.5	55.7

\* Refers to the minimum slab depth  $H_{min}$  for each connector type.

Slab Thickness (mm)	Product Reference	Maximum Width of Joint (mm)					
		10	20	30	40	50	60
180	Staisil-HLD	35	35	35	34	33	32
200		37	37	37	37	37	37
220		39	39	39	39	39	39
240		39	39	39	39	39	39
260		39	39	39	39	39	39
280		39	39	39	39	39	39
300		39	39	39	39	39	39
320		39	39	39	39	39	39

### Position of connectors in slab

The tables on pages 16 and 17 are based on the shear connector being located centrally in the slab edge. If the shear connector is offset from the centreline, the minimum distance between the connector centre and the slab face should be considered as  $H/2$ .

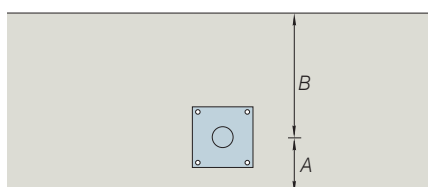

$A < B$   
Slab thickness to be considered in selecting the connector is  $2 \times A$ . Minimum values are shown in the table.

Product Reference	Minimum Slab Depth $H_{min}$	Minimum Depth 'A'
ESD/ESDQ 10	180mm	90mm
ESD/ESDQ 15	180mm	90mm
ESD/ESDQ 20	220mm	110mm
ESD/ESDQ 25	240mm	120mm
ED 10	180mm	90mm
ED 15	180mm	90mm
ED 20	220mm	110mm
ED 25	240mm	120mm
Staisil-HLD	180mm	90mm

**V<sub>Rd</sub> Design Resistance (kN) for Various Joint Widths (mm) and Slab Thickness (mm) using C30/37 Concrete**

Slab Thickness (mm)	Product Reference	Maximum Width of Joint (mm)			
		10	20	30	40
180*	ESD/ESDQ 10	29.1	25.7	22.4	19.7
200		29.6	25.7	22.4	19.7
220		29.6	25.7	22.4	19.7
240		29.6	25.7	22.4	19.7
260		29.6	25.7	22.4	19.7
280		29.6	25.7	22.4	19.7
180*	ESD/ESDQ 15	32.6	31.9	28.1	24.9
200		36.3	31.9	28.1	24.9
220		36.3	31.9	28.1	24.9
240		36.3	31.9	28.1	24.9
260		36.3	31.9	28.1	24.9
280		36.3	31.9	28.1	24.9
220*	ESD/ESDQ 20	53.6	53.6	53.6	52.7
240		62.2	62.2	57.8	52.7
260		69.9	63.5	57.8	52.7
280		69.9	63.5	57.8	52.7
300		69.9	63.5	57.8	52.7
350		69.9	63.5	57.8	52.7
240*	ESD/ESDQ 25	64.4	64.4	61.5	55.7
260		73.7	68.0	61.5	55.7
280		75.4	68.0	61.5	55.7
300		75.4	68.0	61.5	55.7
350		75.4	68.0	61.5	55.7
400		75.4	68.0	61.5	55.7

Slab Thickness (mm)	Product Reference	Maximum Width of Joint (mm)			
		10	20	30	40
180*	ED 10	29.1	25.7	22.4	19.7
200		29.6	25.7	22.4	19.7
220		29.6	25.7	22.4	19.7
240		29.6	25.7	22.4	19.7
260		29.6	25.7	22.4	19.7
280		29.6	25.7	22.4	19.7
180*	ED 15	32.6	31.9	28.1	24.9
200		36.3	31.9	28.1	24.9
220		36.3	31.9	28.1	24.9
240		36.3	31.9	28.1	24.9
260		36.3	31.9	28.1	24.9
280		36.3	31.9	28.1	24.9
220*	ED 20	53.6	53.6	53.6	52.7
240		62.2	62.2	57.8	52.7
260		69.9	63.5	57.8	52.7
280		69.9	63.5	57.8	52.7
300		69.9	63.5	57.8	52.7
350		69.9	63.5	57.8	52.7
240*	ED 25	64.4	64.4	61.5	55.7
260		73.7	68.0	61.5	55.7
280		75.4	68.0	61.5	55.7
300		75.4	68.0	61.5	55.7
350		75.4	68.0	61.5	55.7
400		75.4	68.0	61.5	55.7

\* Refers to the minimum slab depth H<sub>min</sub> for each connector type.

Slab Thickness (mm)	Product Reference	Maximum Width of Joint (mm)					
		10	20	30	40	50	60
180	Staisil-HLD	35	35	35	34	33	32
200		37	37	37	37	37	37
220		39	39	39	39	39	39
240		39	39	39	39	39	39
260		39	39	39	39	39	39
280		39	39	39	39	39	39
300		39	39	39	39	39	39
320		39	39	39	39	39	39

**ESD Design Example**

Slab thickness = 220mm  
 Maximum width of joint = 30mm  
 Concrete strength = C30/37  
 Characteristic dead load = 20kN/m  
 Characteristic imposed load = 26kN/m  
 Design load = (20 x 1.35) + (26 x 1.5) = 66kN/m

$\gamma_G = 1.35^*$   
 $\gamma_Q = 1.5^*$

V<sub>Rd</sub> (Design resistance)  
 ESD10 = 22.4kN = 22.4 / 66 = 0.339m use 330mm  
 ESD15 = 28.1kN = 28.1 / 66 = 0.426m use 400mm  
 ESD20 = 53.6kN = 53.6 / 66 = 0.812m use 800mm

Any of the three connectors would be acceptable, although using ESD20s at 800mm centres would minimise the number of connectors to be installed.

\*The partial safety factors of 1.35 ( $\gamma_G$ ) and 1.5 ( $\gamma_Q$ ) are those recommended in EN 1990 Eurocode: Basis for structural design. For designs to Eurocode 2, please refer to the national annex for the factors to be used in the country concerned.

# DSD/ESD Shear Load Connectors

## ESD Reinforcement Details

Local reinforcement is required around each connector to guarantee that the forces are transferred between the connectors and the concrete. Correct detailing in accordance with appropriate design codes and the recommendations provided here will ensure Ancon ESD, ESDQ, ED and Staisil connectors attain their full capacity.

The tables show proposals for the type and spacing of the main reinforcement, together with details of reinforcement above and below the connectors.

For walls, the reinforcement is repeated as in the tables but with links replacing the U-bars. Links should extend between the near face and the far face of the wall reinforcement.

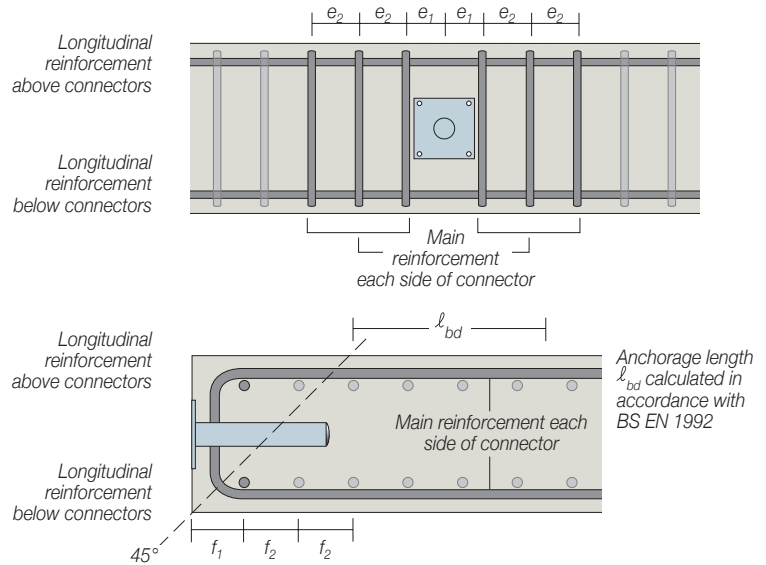

Based on a minimum of C25/30 Concrete, maximum slab depth (see page 16) and 20mm joint

ED/ESD/ESDQ	Options for Main Reinforcement (No. U bars each side)	Spacing (mm)
10	2 H10 1 H12	$e_1 = 35\text{mm}; e_2 = 50\text{mm}$ $e_1 = 35\text{mm}$
15	2 H10 2 H12	$e_1 = 50\text{mm}; e_2 = 40\text{mm}$ $e_1 = 50\text{mm}; e_2 = 40\text{mm}$
20	2 H12	$e_1 = 40\text{mm}; e_2 = 30\text{mm}$
25	3 H12	$e_1 = 45\text{mm}; e_2 = 45\text{mm}$
Staisil-HLD	3 H10 2 H12	$e_1 = 70\text{mm}; e_2 = 74\text{mm}$ $e_1 = 70\text{mm}; e_2 = 139\text{mm}$

ED/ESD/ESDQ	Options for Longitudinal Reinforcement (No. bars top and bottom)	Spacing (mm)
10	2 H10 1 H12	$f_1 = 60\text{mm}; f_2 = 70\text{mm}$ $f_1 = 60\text{mm}$
15	2 H10 1 H12	$f_1 = 60\text{mm}; f_2 = 70\text{mm}$ $f_1 = 60\text{mm}$
20	2 H10 1 H12	$f_1 = 60\text{mm}; f_2 = 70\text{mm}$ $f_1 = 60\text{mm}$
25	2 H10 2 H12	$f_1 = 60\text{mm}; f_2 = 70\text{mm}$ $f_1 = 60\text{mm}; f_2 = 70\text{mm}$
Staisil-HLD	2 H10	$f_1 = 60\text{mm}; f_2 = 70\text{mm}$

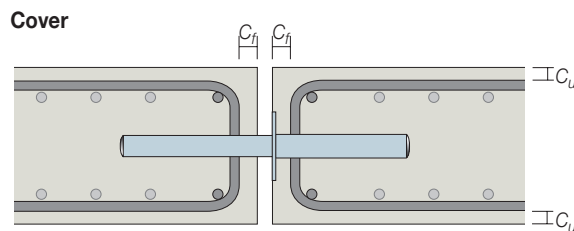
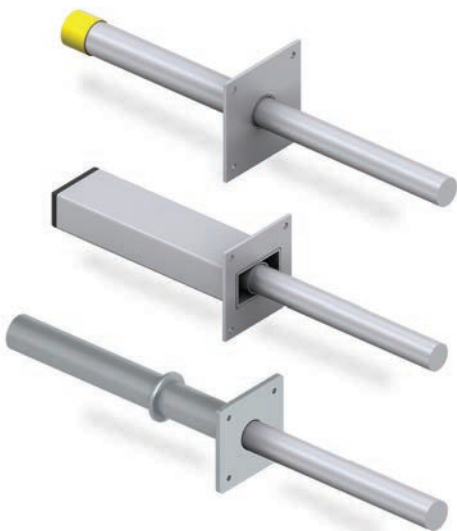
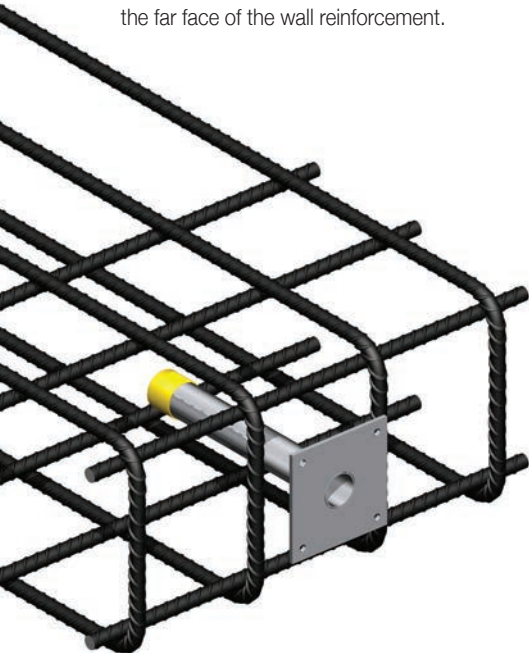

Minimum cover  $C_u$  to local reinforcement is the recommendations of BS EN 1992

Reference	Minimum Cover to Face $C_f$	Maximum Cover to Face $C_u$
10		50mm
15	To be specified by engineer according to BS EN 1992	50mm
20		50mm
25		50mm
Staisil-HLD		50mm



## Applications



Channel Tunnel Terminal, UK



Forum Shopping Centre, Algarve



Melbourne Cricket Ground, Australia



Scottish Widows, Edinburgh, UK



Olympic Stadium, Sydney, Australia

## Other Ancon Products

### Reinforcement Continuity Systems

Ancon Eazistrip is approved by UK CARES and consists of bent bars housed in a galvanised steel casing. Once installed, the protective cover is removed and the bars are straightened, ready for joining to the slab reinforcement. Alternatively, Ancon KSN Anchors are cast into the wall and, when the formwork and thread protection are removed, Bartec Plus threaded rebars are simply screwed into the anchors.



### Reinforcing Bar Couplers

The use of reinforcing bar couplers can provide significant advantages over lapped joints. Design and construction of the concrete can be simplified and the amount of reinforcement required can be reduced. Because the strength of a mechanical splice is independent of the concrete in which it is located, the joint can also remain unaffected by any loss of cover. The range includes parallel threaded, tapered threaded, mechanically bolted and grouted couplers.



### Punching Shear Reinforcement

Used within a slab to provide additional reinforcement around columns, Ancon Shearfix is the ideal solution to the design and construction problems associated with punching shear. The system consists of double-headed studs welded to flat rails, positioned around the column. The shear load from the slab is transferred through the studs into the column.



### Insulated Balcony Connections

Ancon thermally insulated connectors minimise heat loss at balcony locations while maintaining structural integrity. They provide a thermal break and, as a critical structural component, transfer moment, shear, tension and compression forces. Standard solutions are available for concrete-to-concrete, steel-to-concrete and steel-to-steel interfaces.



### Channels and Bolts for Fixing to Concrete

Cast-in channels are used for fixing masonry support systems to the edges of concrete floors and beams. Channels are available in different sizes ranging from simple self-anchoring channels for restraints, to large capacity channels with integral anchors. A selection of channels can also be supplied plain-backed for surface fixing. Stainless steel expansion bolts and resin anchors complete the range.







**Leviat<sup>®</sup>**  
A CRH COMPANY

Innovative engineered products and construction solutions that allow the industry to build safer, stronger and faster.





## Worldwide contacts for Leviat:

### Australia

**Leviat**  
98 Kurrajong Avenue,  
Mount Druitt Sydney, NSW 2770  
Tel: +61 - 2 8808 3100  
Email: info.au@leviat.com

### Austria

**Leviat**  
Leonard-Bernstein-Str. 10  
Saturn Tower, 1220 Wien  
Tel: +43 - 1 - 259 6770  
Email: info.at@leviat.com

### Belgium

**Leviat**  
Industrielaan 2  
1740 Ternat  
Tel: +32 - 2 - 582 29 45  
Email: info.be@leviat.com

### China

**Leviat**  
Room 601 Tower D, Vantone Centre  
No. A6 Chao Yang Men Wai Street  
Chaoyang District  
Beijing · P.R. China 100020  
Tel: +86 - 10 5907 3200  
Email: info.cn@leviat.com

### Czech Republic

**Leviat**  
Business Center Šafránková  
Šafránková 1238/1  
155 00 Praha 5  
Tel: +420 - 311 - 690 060  
Email: info.cz@leviat.com

### Finland

**Leviat**  
Vädursgatan 5  
412 50 Göteborg / Sweden  
Tel: +358 (0)10 6338781  
Email: info.fi@leviat.com

### France

**Leviat**  
6, Rue de Cabanis  
FR 31240 L'Union  
Toulouse  
Tel: +33 - 5 - 34 25 54 82  
Email: info.fr@leviat.com

### Germany

**Leviat**  
Liebigstrasse 14  
40764 Langenfeld  
Tel: +49 - 2173 - 970 - 0  
Email: info.de@leviat.com

### India

**Leviat**  
309, 3rd Floor, Orion Business Park  
Ghodbunder Road, Kapurbawdi,  
Thane West, Thane,  
Maharashtra 400607  
Tel: +91 - 22 2589 2032  
Email: info.in@leviat.com

### Italy

**Leviat**  
Via F.lli Bronzetti 28  
24124 Bergamo  
Tel: +39 - 035 - 0760711  
Email: info.it@leviat.com

### Malaysia

**Leviat**  
28 Jalan Anggerik Mokara 31/59  
Kota Kemuning, 40460 Shah Alam  
Selangor  
Tel: +603 - 5122 4182  
Email: info.my@leviat.com

### Netherlands

**Leviat**  
Oostermaat 3  
7623 CS Borne  
Tel: +31 - 74 - 267 14 49  
Email: info.nl@leviat.com

### New Zealand

**Leviat**  
2/19 Nuttall Drive, Hillsborough,  
Christchurch 8022  
Tel: +64 - 3 376 5205  
Email: info.nz@leviat.com

### Norway

**Leviat**  
Vestre Svanholmen 5  
4313 Sandnes  
Tel: +47 - 51 82 34 00  
Email: info.no@leviat.com

### Philippines

**Leviat**  
2933 Regus, Joy Nostalg,  
ADB Avenue  
Ortigas Center  
Pasig City  
Tel: +63 - 2 7957 6381  
Email: info.ph@leviat.com

### Poland

**Leviat**  
Ul. Obornicka 287  
60-691 Poznań  
Tel: +48 - 61 - 622 14 14  
Email: info.pl@leviat.com

### Singapore

**Leviat**  
14 Benoi Crescent  
Singapore 629977  
Tel: +65 - 6266 6802  
Email: info.sg@leviat.com

### Spain

**Leviat**  
Poligono Industrial Santa Ana  
c/ Ignacio Zuloaga, 20  
28522 Rivas-Vaciamadrid  
Tel: +34 - 91 632 18 40  
Email: info.es@leviat.com

### Sweden

**Leviat**  
Vädursgatan 5  
412 50 Göteborg  
Tel: +46 - 31 - 98 58 00  
Email: info.se@leviat.com

### Switzerland

**Leviat**  
Grenzstrasse 24  
3250 Lyss  
Tel: +41 - 31 750 3030  
Email: info.ch@leviat.com

### United Arab Emirates

**Leviat**  
RA08 TB02, PO Box 17225  
JAFZA, Jebel Ali, Dubai  
Tel: +971 (0)4 883 4346  
Email: info.ae@leviat.com

### United Kingdom

**Leviat**  
President Way, President Park,  
Sheffield, S4 7UR  
Tel: +44 - 114 275 5224  
Email: info.uk@leviat.com

### United States of America

**Leviat**  
6467 S Falkenburg Rd.  
Riverview, FL 33578  
Tel: (800) 423-9140  
Email: info.us@leviat.us

### For countries not listed

Email: info@leviat.com

**Leviat.com**

#### Notes regarding this catalogue

© Protected by copyright. The construction applications and details provided in this publication are indicative only. In every case, project working details should be entrusted to appropriately qualified and experienced persons. Whilst every care has been exercised in the preparation of this publication to ensure that any advice, recommendations or information is accurate, no liability or responsibility of any kind is accepted by Leviat for inaccuracies or printing errors. Technical and design changes are reserved. With a policy of continuous product development, Leviat reserves the right to modify product design and specification at any time.





For more information on these products, contact:

**Leviat**

President Way  
President Park  
Sheffield, S4 7UR  
United Kingdom

Tel: +44 (0) 114 275 5224

Fax: +44 (0) 114 276 8543

Email: [info.ancon.uk@leviat.com](mailto:info.ancon.uk@leviat.com)

For sales and technical enquiries:

Email: [reinforcement.uk@leviat.com](mailto:reinforcement.uk@leviat.com)

[Ancon.co.uk](http://Ancon.co.uk)

[Leviat.com](http://Leviat.com)

**Imagine. Model. Make.**

**[Leviat.com](http://Leviat.com)**